

LP5951

Micropower, 150mA Low-Dropout CMOS Voltage Regulator

General Description

The LP5951 regulator is designed to meet the requirements of portable, battery-powered systems providing a regulated output voltage and low quiescent current. When switched to shutdown mode via a logic signal at the Enable pin, the power consumption is reduced to virtually zero.

The LP5951 is designed to be stable with small 1 μ F ceramic capacitors.

The LP5951 also features internal protection against short-circuit currents and over-temperature conditions.

Performance is specified for a -40°C to 125°C temperature range.

The device is available in SOT23-5 and SC70-5 package.

The device is available in fixed output voltages in the range of 1.3V to 3.3V. For availability, please contact your local NSC sales office.

Features

- Excellent line transient response: ± 2 mV typ.
- Excellent PSRR: -60dB at 1kHz typ.
- Low quiescent current of 29 μ A typ.
- 1.8 to 5.5V input voltage range
- Small SC70-5 and SOT23-5 packages
- Fast turn-on time of 30 μ s typ.
- Typ. < 1nA quiescent current in shutdown
- Guaranteed 150mA output current
- Output voltage range: 1.3V to 3.3V
- Logic controlled enable 0.4V/0.9V
- Good load transient response of 50mVpp typ.
- Thermal-overload and short-circuit protection
- -40°C to +125°C junction temperature range

Applications

- General purpose

Typical Application Circuit

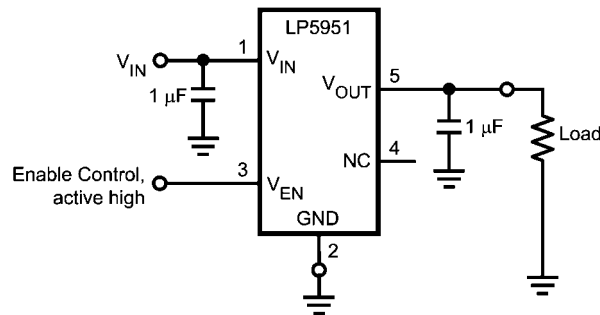

Connection Diagrams

5-Lead Small Outline Package
SOT23-5 (MF)

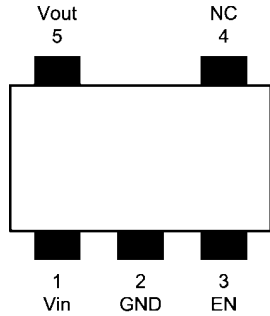

20136202
Top View
See NS Package Number MF05A

5-Lead Small Outline Package
SC70-5 (MG)

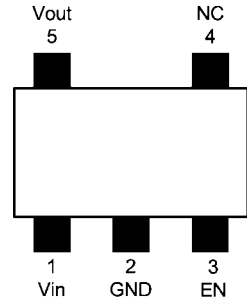

20136203
Top View
See NS Package Number MAA05A

Pin Descriptions

Pin Number	Pin Name	Description
1	V _{IN}	Input Voltage. Input range: 1.8V to 5.5V
2	GND	Ground
3	EN	Enable pin logic input: Low = shutdown, High = normal operation. This pin should not be left floating.
4	NC	No internal connection
5	V _{OUT}	Regulated output voltage

Order Information

For 5-Lead Small Outline Package SOT23-5 (MF)

Output Voltage (V)	LP5951 Supplied as 1000 Units, Tape and Reel	LP5951 Supplied as 3000 Units, Tape and Reel	Flow	Package Marking
1.3	LP5951MF-1.3	LP5951MFX-1.3		LKRB
	LP5951MF-1.3	LP5951MFX-1.3	NOPB	LKRB
1.5	LP5951MF-1.5	LP5951MFX-1.5		LKAB
	LP5951MF-1.5	LP5951MFX-1.5	NOPB	LKAB
1.8	LP5951MF-1.8	LP5951MFX-1.8		LKBB
	LP5951MF-1.8	LP5951MFX-1.8	NOPB	LKBB
2.0	LP5951MF-2.0	LP5951MFX-2.0		LKCB
	LP5951MF-2.0	LP5951MFX-2.0	NOPB	LKCB
2.5	LP5951MF-2.5	LP5951MFX-2.5		LKEB
	LP5951MF-2.5	LP5951MFX-2.5	NOPB	LKEB
2.8	LP5951MF-2.8	LP5951MFX-2.8		LKFB
	LP5951MF-2.8	LP5951MFX-2.8	NOPB	LKFB
3.0	LP5951MF-3.0	LP5951MFX-3.0		LKGB
	LP5951MF-3.0	LP5951MFX-3.0	NOPB	LKGB
3.3	LP5951MF-3.3	LP5951MFX-3.3		LKHB
	LP5951MF-3.3	LP5951MFX-3.3	NOPB	LKHB

For 5-Lead Small Outline Package SC70-5 (MG)

Output Voltage (V)	LP5951 Supplied as 1000 Units, Tape and Reel	LP5951 Supplied as 3000 Units, Tape and Reel	Flow	Package Marking
1.3	LP5951MG-1.3	LP5951MGX-1.3		L23
	LP5951MG-1.3	LP5951MGX-1.3	NOPB	L23
1.5	LP5951MG-1.5	LP5951MGX-1.5		L2B
	LP5951MG-1.5	LP5951MGX-1.5	NOPB	L2B
1.8	LP5951MG-1.8	LP5951MGX-1.8		L3B
	LP5951MG-1.8	LP5951MGX-1.8	NOPB	L3B
2.0	LP5951MG-2.0	LP5951MGX-2.0		L4B
	LP5951MG-2.0	LP5951MGX-2.0	NOPB	L4B
2.5	LP5951MG-2.5	LP5951MGX-2.5		L5B
	LP5951MG-2.5	LP5951MGX-2.5	NOPB	L5B
2.8	LP5951MG-2.8	LP5951MGX-2.8		L6B
	LP5951MG-2.8	LP5951MGX-2.8	NOPB	L6B
3.0	LP5951MG-3.0	LP5951MGX-3.0		L7B
	LP5951MG-3.0	LP5951MGX-3.0	NOPB	L7B
3.3	LP5951MG-3.3	LP5951MGX-3.3		LAB
	LP5951MG-3.3	LP5951MGX-3.3	NOPB	LAB

Note: The package marking on the backside of the component designates the date code and a NSC internal code for die traceability. It will vary considerably.

SOT23-5: ZWTT

SC70-5: WTT

with: Z: 1 Digit Assembly Plant Code, W: 1 Digit Date Code, TT: 2 Digit Dierun Code

Absolute Maximum Ratings (Notes 2, 1)

If Military/Aerospace specified devices are required, please contact the National Semiconductor Sales Office/Distributors for availability and specifications.

V_{IN} pin: Voltage to GND	-0.3V to 6.5V
EN pin: Voltage to GND	-0.3V to ($V_{IN}+0.3V$) with 6.5V max

Continuous Power Dissipation (Note 3)	Internally Limited
Junction Temperature (T_{J-MAX})	150°C
Storage Temperature Range	-65°C to + 150°C
Package Peak Reflow Temperature (10-20 sec.)	240°C
Package Peak Reflow Temperature (Pb-free, 10-20 sec.)	260°C
ESD Rating(Notes 4)	
Human Body Model:	2.0kV
Machine Model	200V

ESD Caution Notice

National Semiconductor recommends that all integrated circuits be handled with appropriate precautions. Failure to observe proper ESD handling techniques can result in damage.

Electrical Characteristics (Notes 2, 7)

Typical values and limits appearing in standard typeface are for $T_A = 25^\circ\text{C}$. Limits appearing in **boldface** type apply over the full operating temperature range: $-40^\circ\text{C} \leq T_J \leq +125^\circ\text{C}$. Unless otherwise noted, $V_{IN} = V_{OUT(NOM)} + 1V$, $C_{IN} = 1\mu\text{F}$, $C_{OUT} = 1\mu\text{F}$, $V_{EN} = 0.9V$.

Symbol	Parameter	Condition	Typ	Limit		Units
				Min	Max	
V_{IN}	Input Voltage	$V_{IN} \geq V_{OUT(NOM)} + V_{DO}$		1.8	5.5	V
ΔV_{OUT}	Output Voltage Tolerance	$I_{OUT} = 1\text{mA}$ $-30^\circ\text{C} \leq T_J \leq +125^\circ\text{C}$		-2.0	2.0	%
	Line Regulation Error	$V_{IN} = V_{OUT(NOM)} + 1V$ to 5.5V $I_{OUT} = 1\text{mA}$	0.1			%/V
	Load Regulation Error	$I_{OUT} = 1\text{mA}$ to 150mA	-0.01			%/mA
V_{DO}	Output Voltage Dropout (Note 10)	$I_{OUT} = 150\text{mA}$ $V_{OUT} \geq 2.5V$ $V_{OUT} < 2.5V$			250	mV
			200		350	mV
I_Q	Quiescent Current	$V_{EN} = 0.9V$, $I_{LOAD} = 0$ $V_{EN} = 0.9V$, $I_{LOAD} = 150\text{mA}$ $V_{EN} = 0V$	29		55	μA
			33		70	μA
			0.005		1	μA
I_{SC}	Output Current (short circuit)	$V_{IN} = V_{OUT(NOM)} + 1V$	400	150		mA
PSRR	Power Supply Rejection Ratio	Sine modulated V_{IN} $f = 100\text{Hz}$ $f = 1\text{kHz}$ $f = 10\text{kHz}$	60			dB
			60			dB
			50			dB
E_N	Output Noise	BW = 10Hz - 100kHz	125			μV_{RMS}
TSD	Thermal Shutdown		160			$^\circ\text{C}$
	Temperature Hysteresis		20			$^\circ\text{C}$

Operating Ratings

(Notes 1, 2)

Input Voltage Range (V_{IN})	1.8V to 5.5V
V_{EN} Input Voltage	0 to ($V_{IN} + 0.3V$)
Junction Temperature (T_J) Range	-40°C to + 125°C
Ambient Temperature (T_A) Range	(Note 5)

Thermal Properties

Junction-to-Ambient Thermal Resistance (θ_{JA}), (Note 6)

SOT23-5 Package:	220°C/W
SC70-5 Package:	415°C/W

Enable Control Characteristics

Symbol	Parameter	Conditions	Typical	Limit		Units
				Min	Max	
I_{EN}	Maximum Input Current at V_{EN} Input	$0V \leq V_{EN} \leq V_{IN}$, $V_{IN} = 5.5V$		-1	1	μA
V_{IL}	Low Input Threshold (shutdown)	$V_{IN} = 1.8..5.5V$			0.4	V
V_{IH}	High Input Threshold (enable)	$V_{IN} = 1.8..5.5V$		0.9		V

Transient Characteristics

Symbol	Parameter	Conditions	Typical	Limit		Units
				Min	Max	
ΔV_{OUT}	Dynamic Line Transient	$V_{IN} = V_{OUT(NOM)} + 1V$ to $V_{OUT(NOM)} + 1V + 0.6V$ in $30\mu s$, no load	± 2			mV
ΔV_{OUT}	Dynamic Load Transient	$I_{OUT} = 0mA$ to $150mA$ in $10\mu s$ $I_{OUT} = 150mA$ to $0mA$ in $10\mu s$ $I_{OUT} = 1mA$ to $150mA$ in $1\mu s$ $I_{OUT} = 150mA$ to $1mA$ in $1\mu s$	-30 20 -50 40			mV mV mV mV
ΔV_{OUT}	Overshoot on Startup	Nominal conditions	10			mV
T_{ON}	Turn on time	$I_{OUT} = 1mA$	30			μs

Output Capacitor, Recommended Specification

Symbol	Parameter	Conditions	Value	Limit (Note 8)		Units
				Min	Max	
C_{OUT}	Output Capacitance	Capacitance (Note 9)	1.0	0.7	47	μF
		$I_{OUT} = 150mA$, $V_{IN} = 5.0V$				
		ESR				

Note 1: Absolute Maximum Ratings indicate limits beyond which damage to the component may occur. Operating Ratings are conditions under which operation of the device is guaranteed. Operating Ratings do not imply guaranteed performance limits. For guaranteed performance limits and associated test conditions, see the Electrical Characteristics tables.

Note 2: All voltages are with respect to the potential at the GND pin.

Note 3: Internal thermal shutdown circuitry protects the device from permanent damage. Thermal shutdown engages at $T_J = 160^\circ C$ (typ.) and disengages at $T_J = 140^\circ C$ (typ.).

Note 4: The Human body model is a 100pF capacitor discharged through a 1.5k Ω resistor into each pin. The machine model is a 200pF capacitor discharged directly into each pin. (MIL-STD-883 3015.7)

Note 5: In applications where high power dissipation and/or poor package thermal resistance is present, the maximum ambient temperature may have to be derated. Maximum ambient temperature (T_{A-MAX}) is dependent on the maximum operating junction temperature ($T_{J-MAX-OP} = 125^\circ C$), the maximum power dissipation of the device in the application (P_{D-MAX}), and the junction-to ambient thermal resistance of the part/package in the application (θ_{JA}), as given by the following equation: $T_{A-MAX} = T_{J-MAX-OP} - (\theta_{JA} \times P_{D-MAX})$.

Note 6: Junction-to-ambient thermal resistance is highly application and board-layout dependent. In applications where high maximum power dissipation exists, special attention must be paid to thermal dissipation issues in board design.

Note 7: Min and Max limits are guaranteed by design, test, or statistical analysis. Typical numbers are not guaranteed, but do represent the most likely norm.

Note 8: Min and Max limits are guaranteed by design

Note 9: The capacitor tolerance should be 30% or better over temperature. The full operating conditions for the application should be considered when selecting a suitable capacitor to ensure that the minimum value of capacitance is always met. Recommended capacitor type is X7R. However, dependent on application, X5R, Y5V, and Z5U can also be used. The shown minimum limit represents real minimum capacitance, including all tolerances and must be maintained over temperature and dc bias voltage (See capacitor section in Applications Hints)

Note 10: Dropout voltage is defined as the input to output voltage differential at which the output voltage falls to 100mV below the nominal output voltage. This specification does not apply for output voltages below 1.8V.

Output Current Derating

Maximum Load Current vs $V_{IN} - V_{OUT}$, $T_A = 85^\circ\text{C}$, $V_{OUT} = 1.5\text{V}$

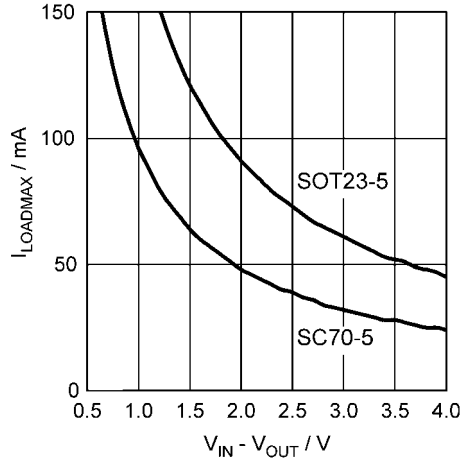

20136204

Block Diagram

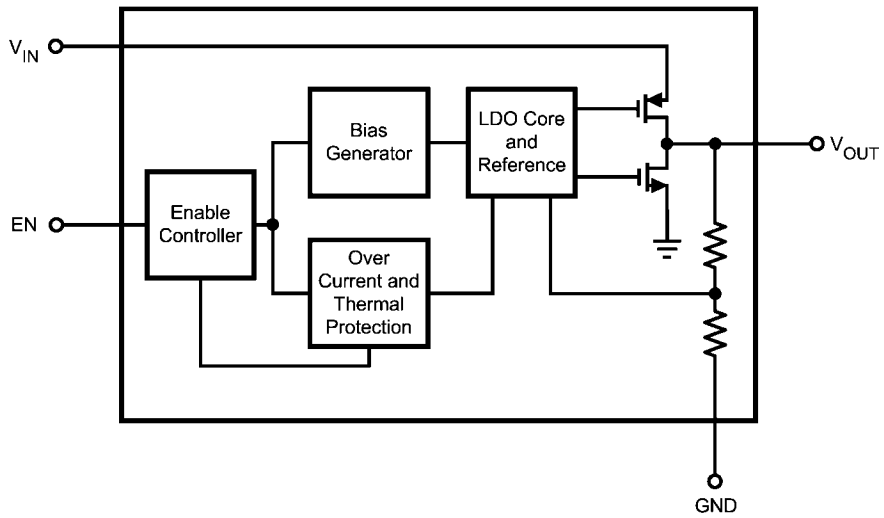

20136205

Typical Performance Characteristics Unless otherwise specified, $C_{IN} = 1\mu\text{F}$ ceramic, $C_{OUT} = 1\mu\text{F}$ ceramic, $V_{IN} = V_{OUT(NOM)} + 1\text{V}$, $T_A = 25^\circ\text{C}$, Enable pin is tied to V_{IN} .

Load Transient Response

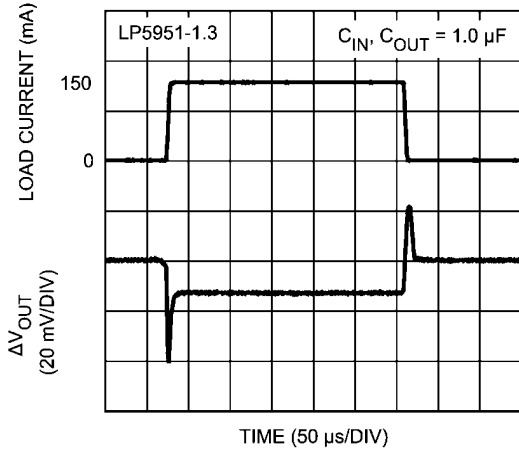

20136209

Load Transient Response

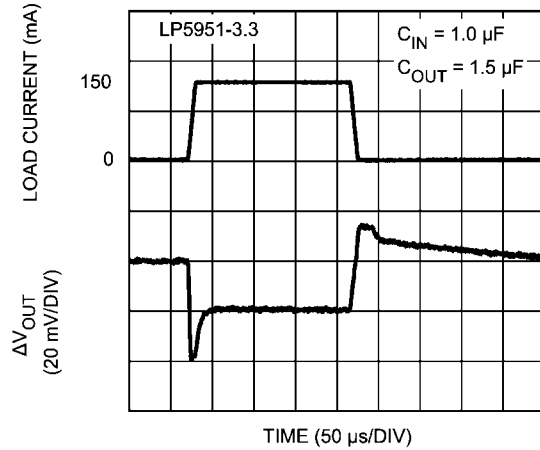

20136210

Line Transient Response

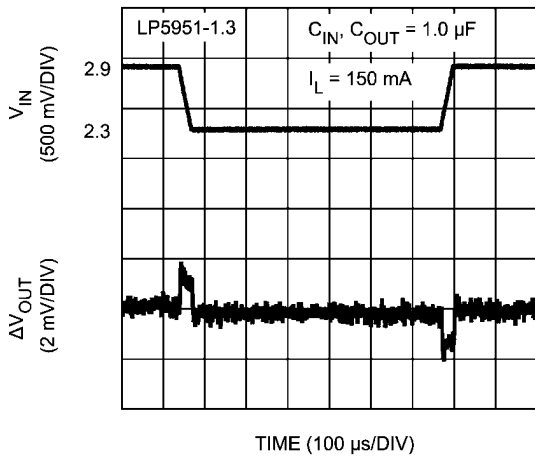

20136211

Line Transient Response

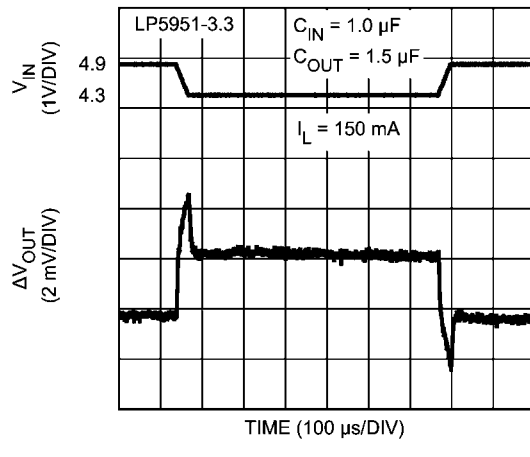

20136212

Enable Start-up Time

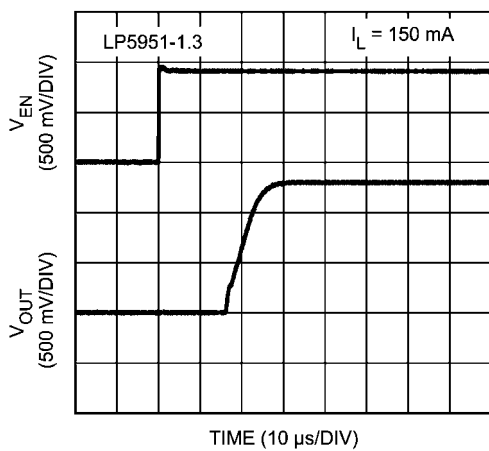

20136213

Enable Start-up Time

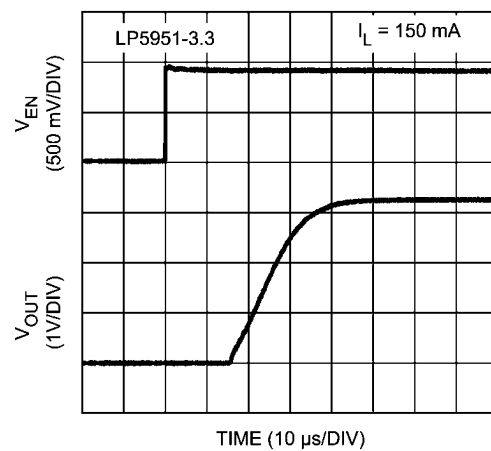

20136214

Output Voltage Change vs Temperature

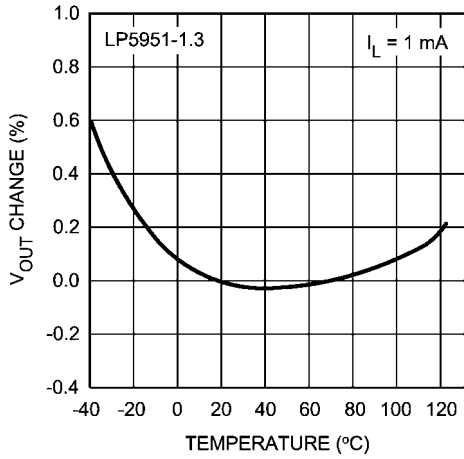

20136217

Ground Current vs V_{IN}

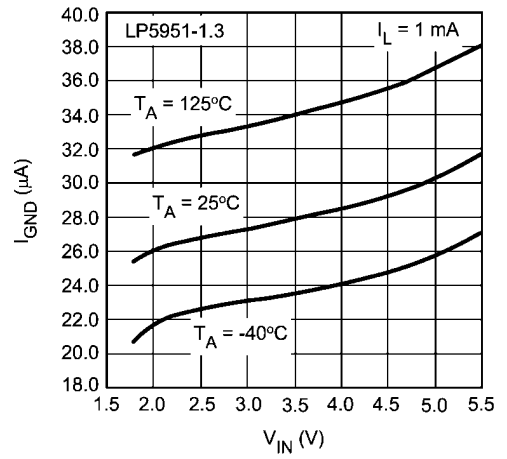

20136216

Power Supply Rejection Ratio

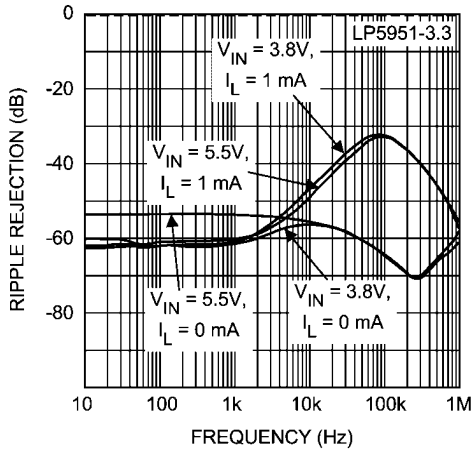

20136215

Application Hints

POWER DISSIPATION AND DEVICE OPERATION

The permissible power dissipation for any package is a measure of the capability of the device to pass heat from the power source, the junctions of the IC, to the ultimate heat sink, the ambient environment. Thus the power dissipation is dependent on the ambient temperature and the thermal resistance across the various interfaces between the die and ambient air.

As stated in (Note 5) in the electrical specification section, the allowable power dissipation for the device in a given package can be calculated using the equation:

$$P_D = (T_{J(MAX)} - T_A) / \theta_{JA}$$

With a $\theta_{JA} = 220^\circ\text{C/W}$, the device in the SOT23-5 package returns a value of 454 mW with a maximum junction temperature of 125°C at T_A of 25°C .

The actual power dissipation across the device can be estimated by the following equation:

$$P_D = (V_{IN} - V_{OUT}) * I_{OUT}$$

This establishes the relationship between the power dissipation allowed due to thermal consideration, the voltage drop across the device, and the continuous current capability of the device. These two equations should be used to determine the optimum operating conditions for the device in the application.

EXTERNAL CAPACITORS

As is common with most regulators, the LP5951 requires external capacitors to ensure stable operation. The LP5951 is specifically designed for portable applications requiring minimum board space and the smallest size components. These capacitors must be correctly selected for good performance.

INPUT CAPACITOR

An input capacitor is required for stability. It is recommended that a $1.0\mu\text{F}$ capacitor be connected between the LP5951 input pin and ground (this capacitance value may be increased without limit).

This capacitor must be located a distance of not more than 1 cm from the input pin and returned to a clean analogue ground. Any good quality ceramic, tantalum, or film capacitor may be used at the input.

Important: Tantalum capacitors can suffer catastrophic failures due to surge current when connected to a low-impedance source of power (like a battery or a very large capacitor). If a tantalum capacitor is used at the input, it must be guaranteed by the manufacturer to have a surge current rating sufficient for the application.

There are no requirements for the ESR (Equivalent Series Resistance) on the input capacitor, but tolerance and temperature coefficient must be considered when selecting the capacitor to ensure the capacitance will remain $\geq 0.7\mu\text{F}$ over the entire operating temperature range.

OUTPUT CAPACITOR

The LP5951 is designed specifically to work with very small ceramic output capacitors. A ceramic capacitor (dielectric types X7R, Z5U, or Y5V) in the $1.0\mu\text{F}$ range (up to $47\mu\text{F}$) and

with ESR between $3\text{ m}\Omega$ to $500\text{ m}\Omega$ is suitable in the LP5951 application circuit.

This capacitor must be located a distance of not more than 1cm from the V_{OUT} pin and returned to a clean analogue ground.

It is also possible to use tantalum or film capacitors at the device output, V_{OUT} , but these are not as attractive for reasons of size and cost (see the section Capacitor Characteristics).

CAPACITOR CHARACTERISTICS

The LP5951 is designed to work with ceramic capacitors on the output to take advantage of the benefits they offer. For capacitance values in the range of $1\mu\text{F}$ to $4.7\mu\text{F}$, ceramic capacitors are the smallest, least expensive and have the lowest ESR values, thus making them best for eliminating high frequency noise. The ESR of a typical $1\mu\text{F}$ ceramic capacitor is in the range of $3\text{ m}\Omega$ to $40\text{ m}\Omega$, which easily meets the ESR requirement for stability for the LP5951.

For both input and output capacitors, careful interpretation of the capacitor specification is required to ensure correct device operation. The capacitor value can change greatly, depending on the operating conditions and capacitor type.

In particular, the output capacitor selection should take account of all the capacitor parameters, to ensure that the specification is met within the application. The capacitance can vary with DC bias conditions as well as temperature and frequency of operation. Capacitor values will also show some decrease over time due to aging. The capacitor parameters are also dependant on the particular case size, with smaller sizes giving poorer performance figures in general. As an example, *Figure 1* shows a typical graph comparing different capacitor case sizes in a Capacitance vs. DC Bias plot. As shown in the graph, increasing the DC Bias condition can result in the capacitance value falling below the minimum value given in the recommended capacitor specifications table ($0.7\mu\text{F}$ in this case). Note that the graph shows the capacitance out of spec for the 0402 case size capacitor at higher bias voltages. It is therefore recommended that the capacitor manufacturers' specifications for the nominal value capacitor are consulted for all conditions, as some capacitor sizes (e.g. 0402) may not be suitable in the actual application.

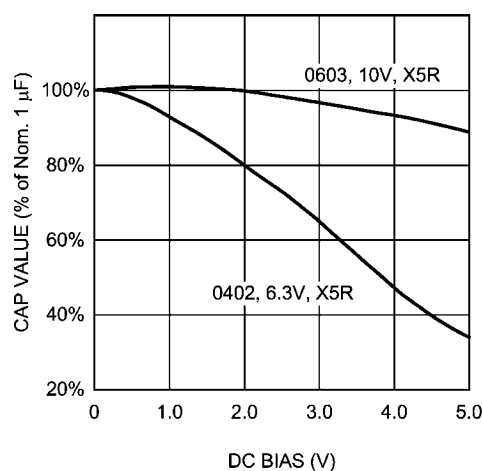

20136206

FIGURE 1. Graph Showing A Typical Variation In Capacitance vs DC Bias

The ceramic capacitor's capacitance can vary with temperature. The capacitor type X7R, which operates over a temperature range of -55°C to $+125^{\circ}\text{C}$, will only vary the capacitance to within $\pm 15\%$. The capacitor type X5R has a similar tolerance over a reduced temperature range of -55°C to $+85^{\circ}\text{C}$. Many large value ceramic capacitors, larger than $1\mu\text{F}$ are manufactured with Z5U or Y5V temperature characteristics. Their capacitance can drop by more than 50% as the temperature varies from 25°C to 85°C . Therefore X7R is recommended over Z5U and Y5V in applications where the ambient temperature will change significantly above or below 25°C .

Tantalum capacitors are less desirable than ceramic for use as output capacitors because they are more expensive when comparing equivalent capacitance and voltage ratings in the $1\mu\text{F}$ to $4.7\mu\text{F}$ range.

Another important consideration is that tantalum capacitors have higher ESR values than equivalent size ceramics. This means that while it may be possible to find a tantalum capacitor with an ESR value within the stable range, it would have to be larger in capacitance (which means bigger and more costly) than a ceramic capacitor with the same ESR value. It should also be noted that the ESR of a typical tantalum will increase about 2:1 as the temperature goes from 25°C down to -40°C , so some guard band must be allowed.

NO-LOAD STABILITY

The LP5951 will remain stable and in regulation with no external load. This is an important consideration in some circuits, for example CMOS RAM keep-alive applications.

ENABLE OPERATION

The LP5951 may be switched ON or OFF by a logic input at the Enable pin, V_{EN} . A logic high at this pin will turn the device on. When the enable pin is low, the regulator output is off and the device typically consumes 5nA.

If the application does not require the Enable switching feature, the V_{EN} pin should be tied to V_{IN} to keep the regulator output permanently on.

To ensure proper operation, the signal source used to drive the V_{EN} input must be able to swing above and below the specified turn-on/off voltage thresholds listed in the Electrical Characteristics section under Enable Control Characteristics, V_{IL} and V_{IH} .

FAST TURN OFF AND ON

The controlled switch-off feature of the device provides a fast turn off by discharging the output capacitor via an internal FET device. This discharge is current limited by the RDSon of this switch.

SUGGESTED CAPACITORS AND THEIR SUPPLIERS

Capacitance / μF	Model	Vendor	Type	Case Size / Inch (mm)
1.0	C1608X5R1A105K	TDK	Ceramic, X5R	0603 (1608)
1.0	C1005X5R1A105K	TDK	Ceramic, X5R	0402 (1005)

Fast turn-on is guaranteed by an optimized architecture allowing a very fast ramp of the output voltage to reach the target voltage.

SHORT-CIRCUIT PROTECTION

The LP5951 is short circuit protected and in the event of a peak over-current condition, the output current through the PMOS will be limited.

If the over-current condition exists for a longer time, the average power dissipation will increase depending on the input to output voltage difference until the thermal shutdown circuitry will turn off the PMOS.

Please refer to the section on thermal information for power dissipation calculations.

THERMAL-OVERLOAD PROTECTION

Thermal-Overload Protection limits the total power dissipation in the LP5951. When the junction temperature exceeds $T_J = 160^{\circ}\text{C}$ typ., the shutdown logic is triggered and the PMOS is turned off, allowing the device to cool down. After the junction temperature dropped by 20°C (temperature hysteresis), the PMOS is activated again. This results in a pulsed output voltage during continuous thermal-overload conditions.

The Thermal-Overload Protection is designed to protect the LP5951 in the event of a fault condition. For normal, continuous operation, do not exceed the absolute maximum junction temperature rating of $T_J = +150^{\circ}\text{C}$ (see Absolute Maximum Ratings).

REVERSE CURRENT PATH

The internal PFET pass device in LP5951 has an inherent parasitic body diode. During normal operation, the input voltage is higher than the output voltage and the parasitic diode is reverse biased. However, if the output is pulled above the input in an application, then current flows from the output to the input as the parasitic diode gets forward biased. The output can be pulled above the input as long as the current in the parasitic diode is limited to 50mA.

For currents above this limit an external Schottky diode must be connected from V_{OUT} to V_{IN} (cathode on V_{IN} , anode on V_{OUT}).

EVALUATION BOARDS

For availability of evaluation boards please refer to the Product Folder of LP5951 at www.national.com. For information regarding evaluation boards, please refer to Application Note: AN-1486.

Notes

THE CONTENTS OF THIS DOCUMENT ARE PROVIDED IN CONNECTION WITH NATIONAL SEMICONDUCTOR CORPORATION ("NATIONAL") PRODUCTS. NATIONAL MAKES NO REPRESENTATIONS OR WARRANTIES WITH RESPECT TO THE ACCURACY OR COMPLETENESS OF THE CONTENTS OF THIS PUBLICATION AND RESERVES THE RIGHT TO MAKE CHANGES TO SPECIFICATIONS AND PRODUCT DESCRIPTIONS AT ANY TIME WITHOUT NOTICE. NO LICENSE, WHETHER EXPRESS, IMPLIED, ARISING BY ESTOPPEL OR OTHERWISE, TO ANY INTELLECTUAL PROPERTY RIGHTS IS GRANTED BY THIS DOCUMENT.

TESTING AND OTHER QUALITY CONTROLS ARE USED TO THE EXTENT NATIONAL DEEMS NECESSARY TO SUPPORT NATIONAL'S PRODUCT WARRANTY. EXCEPT WHERE MANDATED BY GOVERNMENT REQUIREMENTS, TESTING OF ALL PARAMETERS OF EACH PRODUCT IS NOT NECESSARILY PERFORMED. NATIONAL ASSUMES NO LIABILITY FOR APPLICATIONS ASSISTANCE OR BUYER PRODUCT DESIGN. BUYERS ARE RESPONSIBLE FOR THEIR PRODUCTS AND APPLICATIONS USING NATIONAL COMPONENTS. PRIOR TO USING OR DISTRIBUTING ANY PRODUCTS THAT INCLUDE NATIONAL COMPONENTS, BUYERS SHOULD PROVIDE ADEQUATE DESIGN, TESTING AND OPERATING SAFEGUARDS.

EXCEPT AS PROVIDED IN NATIONAL'S TERMS AND CONDITIONS OF SALE FOR SUCH PRODUCTS, NATIONAL ASSUMES NO LIABILITY WHATSOEVER, AND NATIONAL DISCLAIMS ANY EXPRESS OR IMPLIED WARRANTY RELATING TO THE SALE AND/OR USE OF NATIONAL PRODUCTS INCLUDING LIABILITY OR WARRANTIES RELATING TO FITNESS FOR A PARTICULAR PURPOSE, MERCHANTABILITY, OR INFRINGEMENT OF ANY PATENT, COPYRIGHT OR OTHER INTELLECTUAL PROPERTY RIGHT.

LIFE SUPPORT POLICY

NATIONAL'S PRODUCTS ARE NOT AUTHORIZED FOR USE AS CRITICAL COMPONENTS IN LIFE SUPPORT DEVICES OR SYSTEMS WITHOUT THE EXPRESS PRIOR WRITTEN APPROVAL OF THE CHIEF EXECUTIVE OFFICER AND GENERAL COUNSEL OF NATIONAL SEMICONDUCTOR CORPORATION. As used herein:

Life support devices or systems are devices which (a) are intended for surgical implant into the body, or (b) support or sustain life and whose failure to perform when properly used in accordance with instructions for use provided in the labeling can be reasonably expected to result in a significant injury to the user. A critical component is any component in a life support device or system whose failure to perform can be reasonably expected to cause the failure of the life support device or system or to affect its safety or effectiveness.

National Semiconductor and the National Semiconductor logo are registered trademarks of National Semiconductor Corporation. All other brand or product names may be trademarks or registered trademarks of their respective holders.

Copyright© 2007 National Semiconductor Corporation

For the most current product information visit us at www.national.com



National Semiconductor Americas Customer Support Center
 Email: new.feedback@nsc.com
 Tel: 1-800-272-9959

National Semiconductor Europe Customer Support Center
 Fax: +49 (0) 180-530-85-86
 Email: europe.support@nsc.com
 Deutsch Tel: +49 (0) 69 9508 6208
 English Tel: +49 (0) 870 24 0 2171
 Français Tel: +33 (0) 1 41 91 8790

National Semiconductor Asia Pacific Customer Support Center
 Email: ap.support@nsc.com

National Semiconductor Japan Customer Support Center
 Fax: 81-3-5639-7507
 Email: jpn.feedback@nsc.com
 Tel: 81-3-5639-7560